

TIPS & TRICKS

ID200 V2

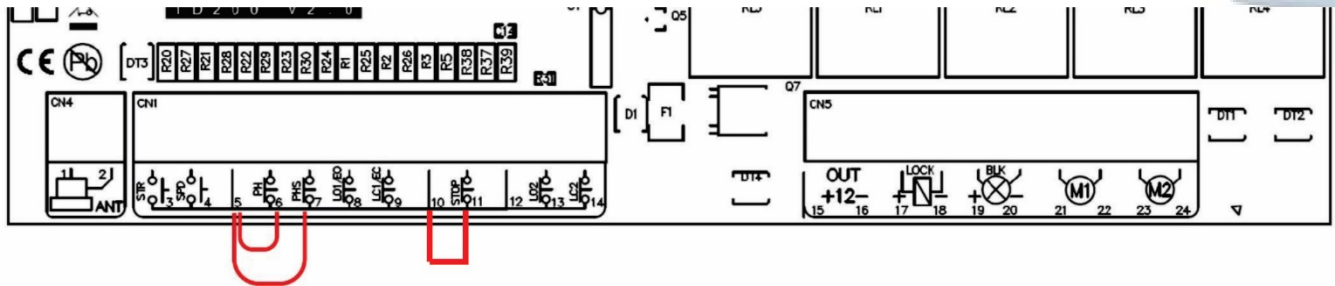

- **TIP** – Always install the motor/s and program using safety loops as described below before installing accessories. Accessories should be installed one by one following successfully installing and programming the motors.
- **TIP** – You need to fit three small loops of wire to your safety inputs to make anything work. These need to be removed later if you install safety devices to these input terminals. But for now, take two pieces of light gauge wire (speaker or telephone wire is good) about 40mm long and strip both ends 7mm and insert them as above from 5 to 6, and 5 to 7. Also 10 to 11.
 - **TIP** - Ensure JP1 on the control board is set to the correct voltage for your system.
- **TIP** – The transformer has two voltages. Use red and black for 12 volts or red and green for 24 volts. These connect to FS3 and FS4.
 - **TIP** – If using one motor only (single gate) use the terminals for Motor 2.
- **TIP** – The manual offers simple setup. It works well. Manual programming gives more control and is used by professional installers to adjust settings. You can also.
- **TIP** – If using solar power refer to the manual for correct input power connection (Last two pages). Also get hold of a copy of the solar power tips n tricks.
- **TIP** – If using wireless keypad KEYPADP6 set it to 20Bit mode to work with this board.

CONVERTING FROM AN OLD K50 OR CTR50

- The terminals from J1 (left side) are now terminals 15 to 24 (right side)
 - The terminals from J2 (middle) are now terminals 3 to 14 (left side)
 - If you are using one motor only still use motor 2. Terminals 23 and 24.
- Your power input and battery connect to the same terminals as the old K50 or CTR50.
- As your installation used the K50 / CTR50 board your mechanical stops should all be in place so you might find it easiest to program using the “AU” method (automatic). You can make adjustments via the menu from there. Just be certain to start with the gates in the fully open position.

Control unit low voltage

For 2 motors

ID200 V2

GB Instructions Manual

Rev. 2,0

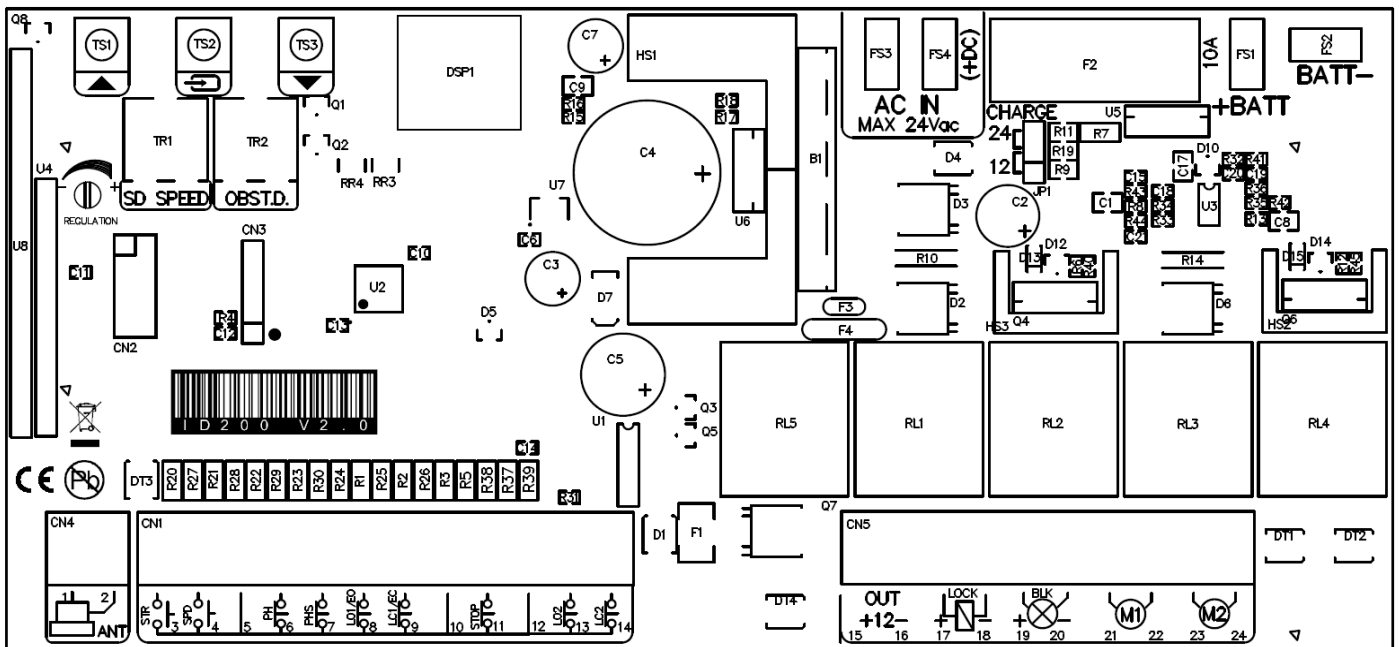

Important: Read carefully this manual before the installation. This manual is integral part of your product, keep it for reference.

Warnings: First of all verify that this product is suitable for the installation. Read carefully technical characteristic before the installation.

Installation of this control unit must be properly done by qualified installers, following rules and regulations of installation country.

It's mandatory do periodic maintenance each 6 month. Maintenance or repairing must be done by qualified Technicians. Turn power off before maintenance or repairing.

This device is intended for gate automation, any other applications is strongly advised.

Not respecting of rules may cause serious damage to peoples, animals, things. Manufacturer discharges all responsibility for missed respect of rules.

Don't let this control unit unattended or where children can reach

Preliminary checking: Before to install this control unit, verify that all the connected devices respect the technical characteristics mentioned in the table which follows. Verify that a working and suitable life switch is installed upline the installation. Verify that cables composing the installation, are suitable for it.

Technical characteristics

Power Supply	12-20Vac/100-200VA
Max. Current out	250mA
Embedded Battery charger	12/24V 100mA
Max motor current	8A (200VA transformer)
Max flashing light current	1A
Max electriclock current	2A
Operating temperature range	-5 +60°C
Backup battery	(2x) 12V 4.5Ah

Wiring Main functions

(1) Just a battery voltage can be connected at once, or 12 or 24V.

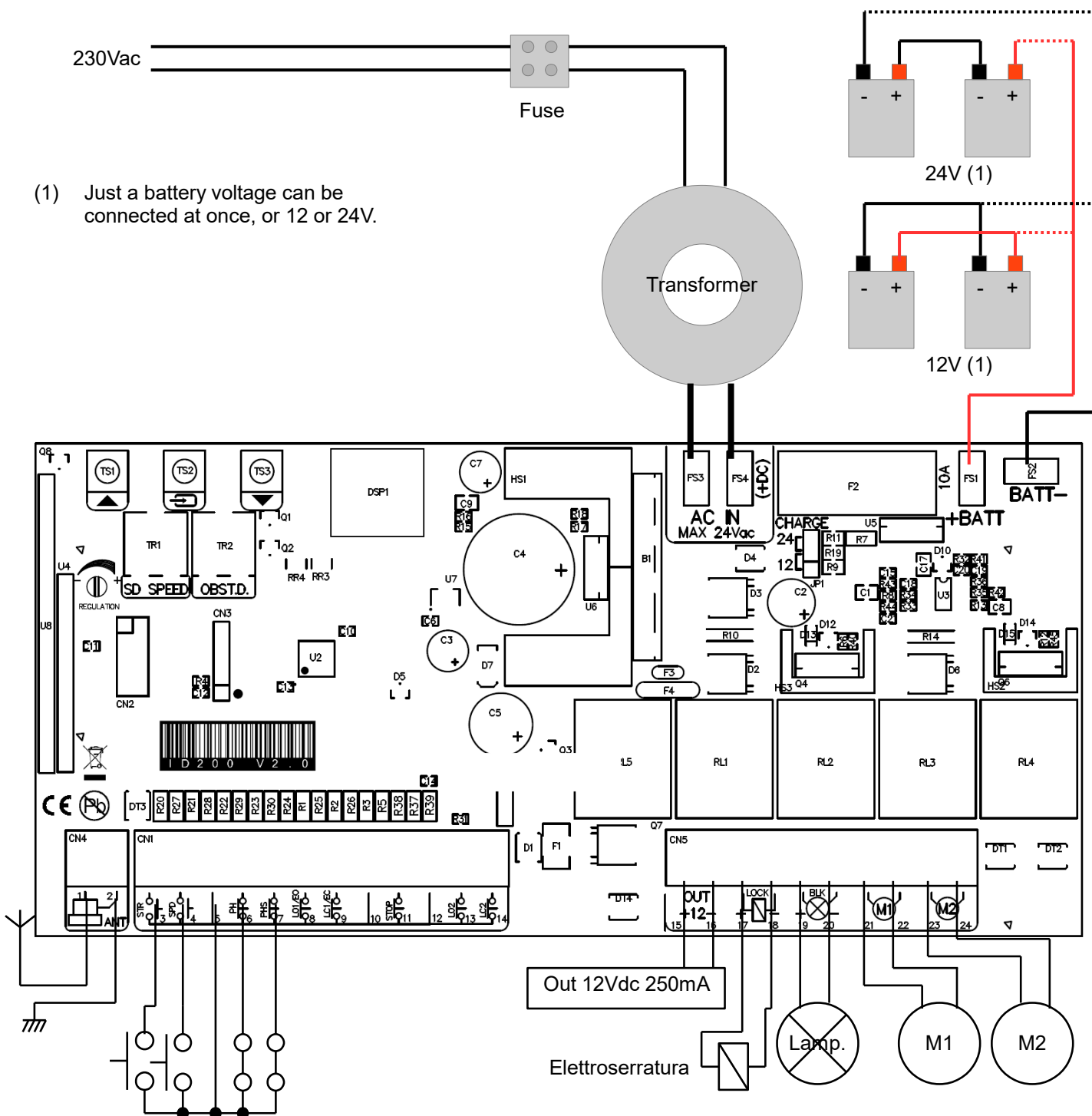

- 1 Antenna.
- 2 Antenna's shield.
- 3 Start input N.O. or Open input N.O. (See menu operative logic "□L").
- 4 Start Pedestrian input N.O. or Open input N.O. (See menu operative logic "□L").
- 5 Common
- 6 Photocells input N.C. or N.O (see advanced menu "□C").

7	Photostop input N.C. or Detect input N.O. (see advanced menu “SF”).
8	Opening Edge or Limit Switch open for slave motor 1 (see advanced menu “E□”).
9	Closing Edge or Limit Switch close for slave motor 1 (see advanced menu “E□”).
10	Common.
11	Stop input N.C. o N.O. (see advanced menu “SP”).
12	Common.
13	Limit Switch open for master motor 2. Left unconnected both limit switches 2 they are automatically disabled.
14	Limit Switch close for master motor 2. Left unconnected both limit switches 2 they are automatically disabled.
15-16	Aux power supply output 12Vdc 250mA.
17-18	Electric lock output (12/24Vdc, according to transformer output).
19-20	Flashing light output (12/24Vdc, 1A, according to transformer output). With blinking or fix output. A very slow blinking it alerts for power failure.
21-22	Output slave motor 1 (12/24Vdc, according to transformer output).
23-24	Output master motor 2 (12/24Vdc, according to transformer output).
TR1	Slow down speed trimmer.
TR2	Obstacle detection sensitivity trimmer.
TS1	Up button.
TS2	Enter button.
TS3	Down button.
DSP	Display
FS3- FS4	Transformer input 12-20Vac / 100-200VA
F2	Rapid fuse 10A.
FS1- FS2	Backup battery in 12/24Vdc (attention: select right value)
JP1	Charger voltage selector for backup battery: 12/24Vdc

Inputs status

When the control unit is in standby, user can read inputs status on display:

- - : No inputs active.
- SP : Stop input active.
- PS : Photostop input active.
- E□: Analog edge opening input active.
- E□: Analog edge closing input active.
- P□ : Photocells input active.
- SE : Start input active.
- P□ : Pedestrian input active.
- P : Open input active.
- L : □lose input active.
- : Limit switch open motor 1 (slave) active.
- : Limit switch close motor 1 (slave) active.
- : Limit switch open motor 2 (master) active.
- : Limit switch close motor 2 (master) active.

During pause, the display show the seconds countdown to closing.

Trimmers setting

Slow down speed trimmer regulates the slow down speed. Do not set speed too low (less than 10cm/sec on the wing edge) to avoid that gate stops in very cold conditions.

Obstacle sensibility trimmer fine tunes the obstacle detection level learned by the control unit during working times programming. This fine regulation must be do after working times learning.

Normally the trimmer goes in the center, in this position it should suit most installations. If it is necessary to resolve problems related to norms or to environmental situations (ex. strong wind) is it possible to regulate this trimmer increasing or decreasing sensibility.

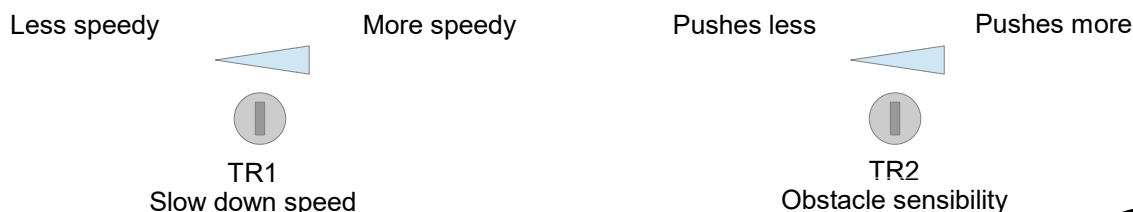

Simple Setup



1. Check motor direction

Push and release the ENTER button. The display will show $\square L$. Use UP/DOWN buttons to select $\square \uparrow$. Press ENTER and now select available options (Open motor 1, Close motor 1 etc.) and hold the ENTER button down to check your motor direction. Example - If you only have one motor it should be connected to M2. Use the option $\square \uparrow$ to check that motor is opening. If not stop - reverse the two motor wires in M2 and test again. When happy with motor/s direction you can exit this menu and again to exit all menus.

To exit this menu select $\square H$ or push up and down together.
After 20 seconds without actions, control unit exits itself from this menu.

2. Choose single or double gate mode.

The control board by default is set to double gate so this next step is only for single gate installations. To enter advanced menu hold down the ENTER button for 4 seconds, until the display shows $\square \uparrow$. Use the UP/DOWN buttons to select $\square \square$. Use the UP/DOWN buttons to find $\square \square$ and press ENTER to select for single gate mode.

To exit this menu select $\square H$ or push up and down together.
After 20 seconds without actions, control unit exits itself from this menu.

3. Quick program.

To program the working times, open the gate/s, then keep pushed UP till you read $\square \square$ on the display. The control unit will do several tests and then it will learn working times. When the procedure is finished the LED screen returns to normal.

4. Quick radio code learning.

Push the DOWN button, " $\square \downarrow$ " will appear on display. Transmit with the remote to be learnt as Start or Open command (according to " $\square L$ " menu). Push twice DOWN to select pedestrian start

5. Quick radio code erasing:

Hold down DOWN button up to on display it appears " $\square \downarrow$ " (5 seconds about), then release the button. All codes are now erased.

6. Auto learning transmitters.

It's possible to learn transmitters quickly without using the base menu. To insert a new transmitter transmit 3 times with the new remote, making at least 1 second pause between each transmission. Than transmit 3 times with a transmitter already in memory and then once with the new. When programming is done, the blinker flash once. **Attention:** function must be enabled, refer to "advanced menu" - auto learning transmitters. The new code takes the same channel as the one used to insert it.

Board Programming

Main menu

Push Enter button shortly, on the display will appear **oL**. With up/down it's possible to select all items in this menu.

To exit this menu select **EH** or push *up* and *down* together.

After 20 seconds without actions, control unit exits itself from this menu.

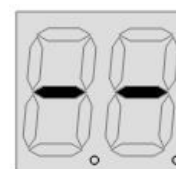

Push shortly
Enter



Display	Function	Choiches	Description	Default
oL	Operative logic	St At cd oc oA EH	Step By Step. Step by step with automatic closing. Condominium mode. Open / Close mode (Start and Pedestrian inputs become Open and Close inputs). Open / Close mode with automatic closing (Start and Pedestrian inputs become Open and Close inputs). Exit.	St
Lc	Learning/ removing transmitters	cl cl rt rn rA EH	Learn Start / Open command (according to oL menu). Learn Pedestrian / Close command (according to oL menu). Removing a remote transmitting its own code. Removing a remote according memory position. Removing all the remotes, must confirm with "45" Exit.	-
Lt	Learn working time	At rn	Attention , before to start learning working times the gate must be set completely open for automatic procedure, while completely closed for manual mode learning. You could use dead man mode " cl " to do it. Is it possible to use a shortcut to start automatic working time procedure, see quick programming chapter. Automatic working times learning (Set the gate fully open before to start the procedure). Attention : in all the procedure safety devices are disabled. The gate pushes in opening direction for a while, than it start closing. In this phases the obstacle detection levels and working times are detected. If you are using a single motor, please set the single motor mode by using " Sc " menu, and connect the motor on output 2 (master). Manual working times learning (set gate fully closed before to start this procedure). Attention : it's need to learn at least a remote in memory before to start the procedure. in all the procedure safety devices are disabled. The gate starts opening, in this phase you can set the slowing down speed by the related trimmer. When the gate is fully open, push enter button or transmit with a remote. In this phase the obstacle detection values are detected, when the test is done rl appears on the display. In the next steps, the enter button or a memorised remote act as it follows: slave motor 1 starting closing, master motor 2 start closing, slow down motor 1 starts, slow down motor 2 starts, stop motor 1, stop motor 2. If you are installing a single gate motor, set the times just for 1 motor.	-
SP	Automatic closing pause time	0- 99	Set the automatic closing pause time in seconds.	10

Main menu (Continue)

Display	Function	Choiches	Description	Default
d1	Dearman mode	o 1 c 1 o 2 c 2 EH	Open motor 1. Close motor 1. Open motor 2. Close motor 2. Exit.	-
EH	Exit	-	Exit from main menu.	-

Board programming

Advanced menu

To enter advanced menu hold down enter button 4 seconds, till on display it appear E1. With up/down it's possible to select all items in this menu.

To exit this menu select EH or push up and down together.

After 20 seconds without actions, control unit exits itself from this menu.

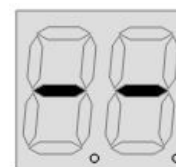

Push Enter 4 seconds



Display	Function	Choiches	Description	Default
E1	Time menu	E 1 S 1 E 2 S 2 d o d c E L EH	Working time slave motor 1 (in seconds). Slowing down start time (since start) of slave motor 1. Working time master motor 2 (in seconds). Slowing down start time (since start) of master motor 2. Delay time of slave motor in opening direction (in seconds). Delay time of master motor 2 in closing direction (in seconds). Electric lock on time. If set to 0 the lock output works as Open gate light (ON when gate is open). Exit. Attention: For the motors times you can set time longer than 2 digits. When the value is over 100 the decimal dot point of 2 nd digit will be on. Example: 15. = 115. When the value is over 200 both the the decimal dots are on. Example: 1.2. = 212.	25 22 25 22 02 05 02
S0	Single motor mode	Y5 nE	Single motor gate Double wing gate	nE
d2	Resets to defaults	Y5 nE EH	Confirming with Y5 the control unit is reset to factory defaults. Attention, this procedure doesn't erase the radio codes.	-
r c	Release motor pressure.	Y5 nE	The gate reverses for few tenths once he has reach the end. Normal operations.	nE
A r	Automatic remotes learning	Y5 nE	Automatic remotes learning enabled. Automatic remotes learning disabled.	nE
c 5	Kickback stroke	Y5 nE	Kickback stroke enabled. Kickback stroke disabled.	nE
S 5	Soft start	Y5 nE	Soft start enabled. Soft start disabled.	Y5
S L	Limit switches in series to the motor	Y5 nE	Limit switches in series to the motor (opening the circuit) Normal operations.	nE

Advanced menu (Continue)

Display	Function	Choiches	Description	Default
r n	Radio mode	1b 4b	Each radio button is learned separate. The installed can choose ho to learn a code: (c 1 Start/Open, c 2 Pedestrian/close). Learning a button of a remote, let all the other 3 buttons being learn automatically.	1b
L n	Electric Lock mode	45 n t	Magnetic electric lock. Impulsive electric lock.	n t
E o	Opening Edge mode	d5 n o n c A n L5 EH	Disabled. Normally Open. Normally Close. Analogic input 8K2. Limit switch open slave motor 1 Exit.	d5
E c	Modo costa chiusura	d5 n o n c A n L5 EH	Disabled. Normally Open. Normally Close. Analogic input 8K2. Limit switch close slave motor 1 Exit.	d5
P c	Photocell mode	n c n o	Normally Open. Normally Close. Attention: Rules of several countries forbid to use safety systems with N.O. Output. Please be sure of safety regulations of your country before to modify this parameter.	n c
S P	Stop mode	n c n o	Normally Open. Normally Close. Attention: Rules of several countries forbid to use safety systems with N.O. Output. Please be sure of safety regulations of your country before to modify this parameter.	n c
S F	Safety input mode	P5 d t	Photostop mode N.C. (Photocell operating in opening mode too) Detect mode N.O.(Photocell for rapid close after the car has passe through the gate)	d t
L5	Limit switches mode (all 4 LS)	n c n o	Normally Close. Normally Open.	n c
b L	Blinker mode	45 n t	Flashing output. Fix on output.	45
c n	Cycles counter	-	Shows cycle counter in 3 group of 2 digits. Example: 123.456 is shown as: 12 - 34 - 56	-
E H	Exit	-	Exits advanced menu.	-

GENERAL SOLAR NOTES

SOLAR PANEL SIZE

Generally speaking simple automatic gate installations will work perfectly in Australia using a 10 watt solar panel. The solar panel size determines the amount of energy you can collect each day. In a simple gate installation we need to collect enough energy to power our control board and run the gate and a 10 watt panel will do this. If however the installation is to include keypads, safety beams or other power hungry devices it may be necessary to increase the solar panel size. Another example where you may wish to consider upsizing your solar panel is where you may have a partially shaded area and you need to collect your energy each day in a shorter period of time. If you do decide to increase the size of your solar panel it may be necessary to install a simple regulator to protect your battery. Check with Automatic Solutions regarding this.

SOLAR PANEL DIRECTION

Your solar panel ideally should be mounted at an angle of 35 degrees and facing north (NB: In Australia).

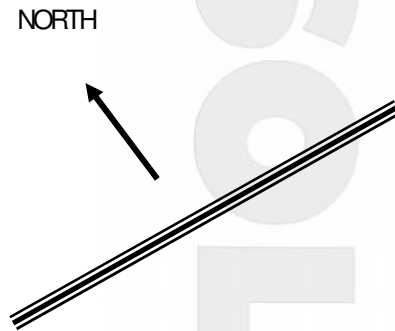

BATTERY SIZE

The battery stores the energy that you collect each day and your system draws on this battery to operate. All batteries have a limit to their storage capacity and can therefore only store enough energy to last our system a certain period of time. What happens if we have for example three days with little or no sunlight, very dark and overcast days? Our battery capacity reduces. The size of the battery will determine the number of days we can have as backup or how many days our system can survive without charging. In general terms bigger is better.

CABLES

Cables must be low voltage cables (5mm is good). Length of cables must be kept to a minimum. Ideally the solar panel will be no more than 10 metres from the battery and the battery will be no more than 5 metres from the motor. Connections must be clean and good quality.

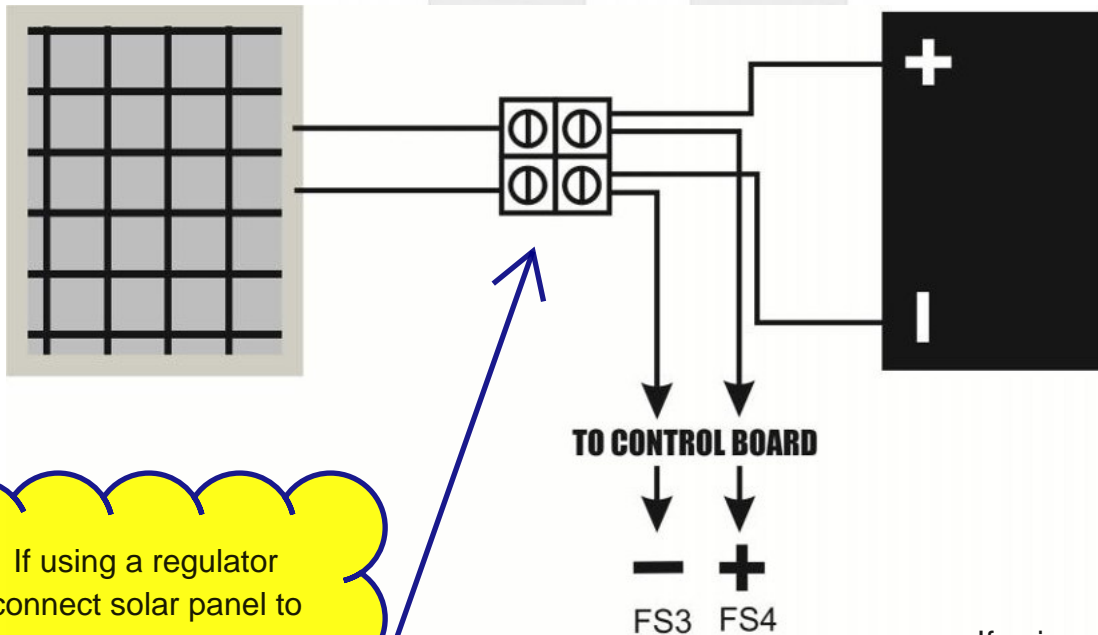

If using a regulator connect solar panel to regulator, regulator to battery and then battery to control board. Do not take the board to the regulator.

If using a regulator go solar panel to regulator, regulator to battery and then battery to control board. Do not take the board to the regulator.

Solar Panel Connection ID200

